



Industrial Device Servers

- ▶ Connect enterprise (ERP, MES) systems to factory floor devices without disturbing existing control networks
- ▶ Allow remote firmware upgrades, saving money and time from manual upgrades
- ▶ IAP version supplies many industrial communication protocols
- ▶ Configurable serial interface supports RS-232, RS-422, or RS-485
- ▶ 10Base-T/100Base-TX Ethernet (RJ45)
- ▶ Isolated serial and Ethernet ports
- ▶ FM-approved for hazardous locations Class I, Div. 2
- ▶ RoHS compliant



Remotely Configure, Program, Monitor, and Manage: PLCs, drives, process controls, power monitoring equipment, barcode scanners, and other factory floor serial devices

The XPress DR and XPress DR-IAP Device Servers enable virtually any industrial device with serial capability to be connected to a new or existing Ethernet network.

By encapsulating serial data and transporting it over Ethernet, the XPress DR/DR-IAP establishes virtual serial links over Ethernet. By using these units, limited-distance, point-to-point, direct serial connections can now be extended within the plant, throughout the facility, or across the global enterprise.

When used in conjunction with an OPC server, most Windows® based HMI, SCADA, and PC-based control applications have full access to information in the connected device. Existing COM-port based Windows® applications can access network-enabled devices using our Com Port Redirector software. Redirector software allows the creation of virtual serial ports, which can be mapped to the remote device servers over Ethernet and connected to the XPress DR and XPress DR-IAP.

The XPress DR-IAP installable communication drivers allow specific support for various industrial communication protocols. With native support for these protocols, devices that previously allowed only one connection can now support multiple connections simultaneously.

Flexible configuration options allow the unit to be set up locally using the serial port, or remotely over Ethernet using Telnet or a common web browser. Included Windows® based configuration software simplifies the process of installing communication drivers and configuring them for use with attached devices. Flash memory provides for maintenance-free, non-volatile storage, and allows future system upgrades.

Packaged in a rugged DIN-rail mount case and featuring 2000V galvanic isolation, 1500V Ethernet isolation, a wide 0° to 60°C operating range, and a 9-30VDC/9-24VAC power input, the XPress DR and XPress DR-IAP are ideal for any industrial application.



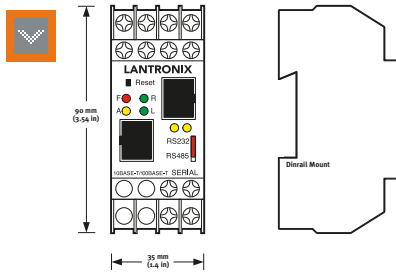

Features

Serial Interface

- Interface: RS-232, RS-422, or RS-485
- Connector: Screw terminals or RJ45
- Data Rates: 300 to 115,200 bps
- Characters: 7 or 8 data bits
- Parity: odd, even, none
- Stop Bits: 1 or 2
- Flow Control:
 - Software: XON/XOFF
 - Hardware: RTS/CTS
- Installable Serial Protocols (XPress DR-IAP only)

Network Interface

- Standards: ARP, UDP/IP, TCP/IP, ICMP, SNMP, BOOTP, DHCP, TFTP, Telnet, and HTTP
- Interface: 10Base-T/100Base-TX Ethernet
- Connector: RJ45
- Installable application layer protocols (XPress DR-IAP only)

Indicators

- Ready, Fault/Configuration, Activity, Link, Serial Transmit Data, Serial Receive Data

Management

- SNMP, serial, Telnet, and HTTP (web browser)

Isolation

- Ethernet: 1500 Vrms
- Serial: 2000 Vrms

Power

- Input: 9 to 30VDC/9-24VAC, 3W maximum
- Connector: Screw terminals for power and ground

Environmental (Operating)

- Temperature: 0° to 60°C (32° to 140°F)
- Humidity: 20% to 90% RH, non-condensing

Packaging

- Mounting: DIN-rail (35 mm)
- Material: High-impact plastic
- Dimensions: 60 x 36 x 90 mm (2.4 x 1.4 x 3.54 in)

Agency Approvals

- UL, CSA, TUV, FCC, CE, FM Class I, Div. 2

Warranty

- 1-year limited warranty

Software

- Included Windows® 95/98/ME/NT/2000-based configuration software simplifies initial setup

Example Configurations

Master/Slave Application

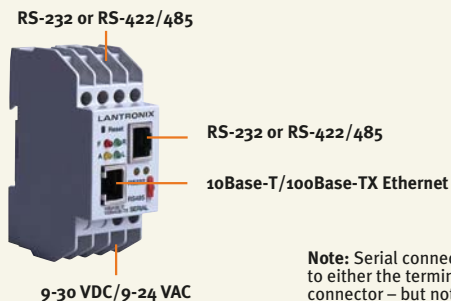
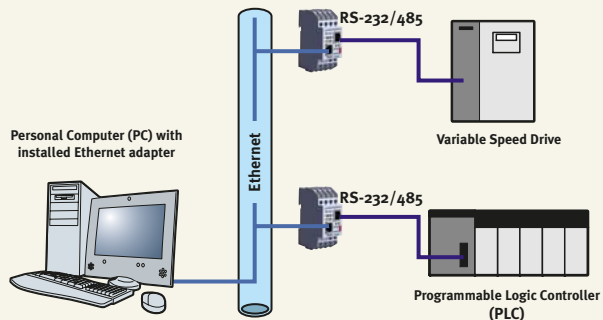
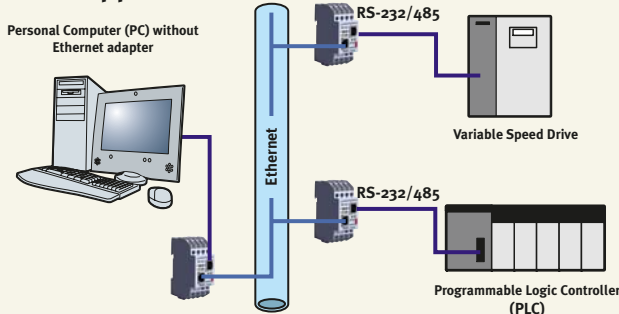

Note: Serial connections may be attached to either the terminal block or to the RJ45 connector – but not both simultaneously.

Shipping Dimensions (L x W x H)

187.3 x 228.6 x 111 mm (7.375 x 9.0 x 4.375 in)

Part Numbers

XSDRSN-02 XPress-DR: standard part
XSDRIN-02 XPress-DR-IAP with installable industrial protocols

Industrial Device Server, DIN-rail mounting, serial interface (RS-232, RS-422, RS-485 – terminal block or RJ45), 10Base-T/100Base-TX Ethernet, diagnostic LEDs, 9VDC to 30VDC power input, CD-ROM with configuration tools, installable communication drivers, and Installation Guide.



15353 Barranca Parkway | Irvine | CA 92618 | USA | Tel: 800.422.7055 | Fax: 949.450.7232 | www.lantronix.com

©2006, Lantronix, Inc. Lantronix is a registered trademark and Device Server is a trademark of Lantronix, Inc. All other trademarks are the property of their respective owners. Specifications subject to change without notice. 910-394 06/06 DGS2500